

DL 06-165/T

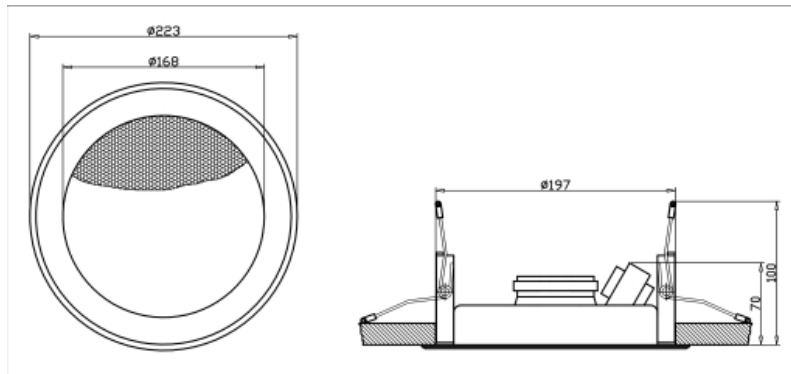

Technical Specifications:

Type:	DL 06-165/T
Power:	6/3/1,5 W
Frequency Range:	100 - 16.000 Hz
<u>SPL 1W/1m:</u>	97,9 dB
<u>SPL Pmax/1m:</u>	105,7 dB
Dimensions:	220x100 mm
Ceiling Cut-out:	197 mm
Temperature range:	-20 / +80 °C
Dispersion angle (-10dB):	180° (H) / 180° (V)
Weight:	1,3 kg
Packing Unit:	12
Protection Class:	
Fire Protection (DIN4102):	
Mounting:	Quick fit mounting
Connector:	Steckverbindungsklemme
Colour:	RAL 9010



Product Attributes:



DL 06-165/T

Frequency Diagrams:

Sound Pressure Level

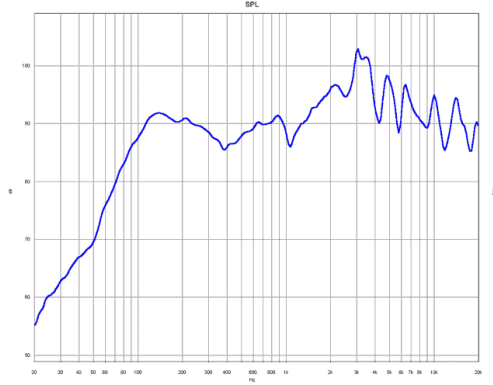

Impedance

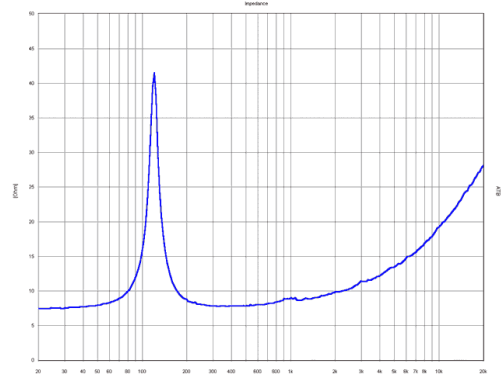

Polar Diagrams (H)

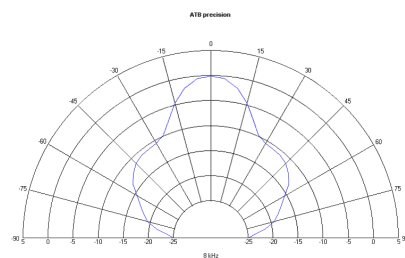
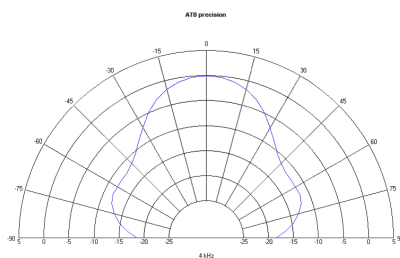
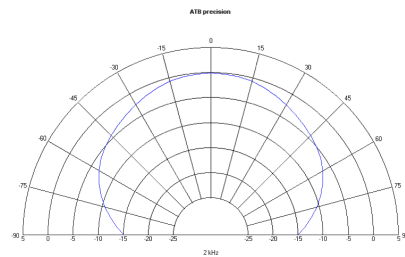
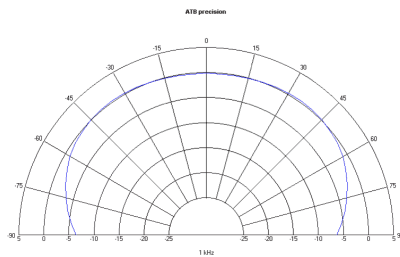
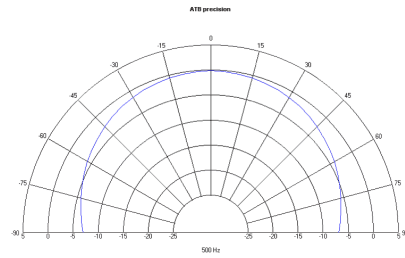
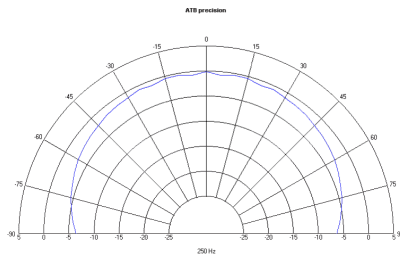



ic audio GmbH • Boehringerstraße 14a • D-68307 Mannheim • Germany
Fon: ++49 (0) 621 / 77096 -0 • Fax: ++49 (0) 621 / 77096 -26 • Email: info@ic-audio.com

DL 06-165/T

Frequency Diagrams:

Measurements according to DIN IEC 268-5

ic audio GmbH • Boehringerstraße 14a • D-68307 Mannheim • Germany
Fon: ++49 (0) 621 / 77096 -0 • Fax: ++49 (0) 621 / 77096 -26 • Email: info@ic-audio.com