

Curved & Straight Cylindric Wave Radiators **L-Series**

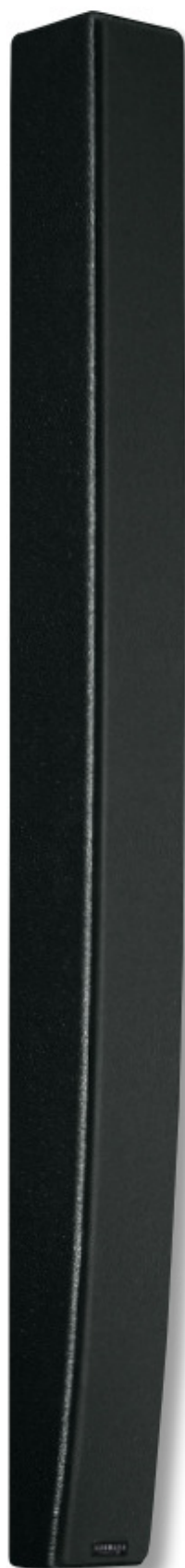

L 16j



L 8c

Ultra thin, low-profile loudspeakers for sophisticated applications in acoustically problematic rooms like churches, auditoriums and theatres. The horizontal coverage and the coupling of the 3" broadband drivers have been optimised by the use of waveguides. The L-Series comprises a total of six models of varying line length and curving and which can be combined as desired. The system is suitable for tackling a multitude of sound applications.



Speakon connectors are a standard feature.



Other colours on request.

PRODUCT SPECIFICATIONS



Speaker Components	4 x 3" wideband	8 x 3" wideband			16 x 3" wideband	
Description	Curved Cylindric Wave Radiator	Curved	Curved	Straight	Curved	Straight
Powerhandling AES / Peak	80 W / 240 W	160 W / 480 W			320 W / 960 W	
Impedance nominal	8 Ω (32 Ω optional)	16 Ω (4 Ω / 64 Ω optional)			8 Ω (32 Ω / 128 Ω optional)	
SPL 1 W / Peak @ 1 m	92 dB / 112 dB (*)	94 dB / 118 dB (*)			96 dB / 124 dB (*)	
Usable Range -6dB	150 Hz - 16 kHz	150 Hz - 16 kHz			150 Hz - 16 kHz	
Coverage horizontal / vertical	80° x 37°	80° x 37°	80° x 17°	80° x 7°	80° x 17°	80° x 7°
Splay Angle	30°	30°	10°	0°	10°	0°
Connectors	2 x Neutrik Speakon NL4MP in/out, Coding: 1 +/- HiMid, 2 +/- loop thru, (Phoenix on request)					
Handles	---	---	---	---	---	---
Rigging / Fittings	3 x M10 / 4 x M6	3 x M10 / 6 x M6			3 x M10 / 6 x M6	
Coating and Finish	Black Polyurea coating and black textile cover, other colours on request					
Weight	3,0 kg	5,0 kg	5,0 kg	5,0 kg	9,0 kg	9,0 kg
Size height x width x depth	35,0 x 11,0 x 12,0 cm	67,0 x 11,0 x 12,0 cm			132,0 x 11,0 x 12,0 cm	
Order No.	00710	00720	00725	00715	00735	00730

* (Measured in 4,0 m distance, converted to 1,0 m)

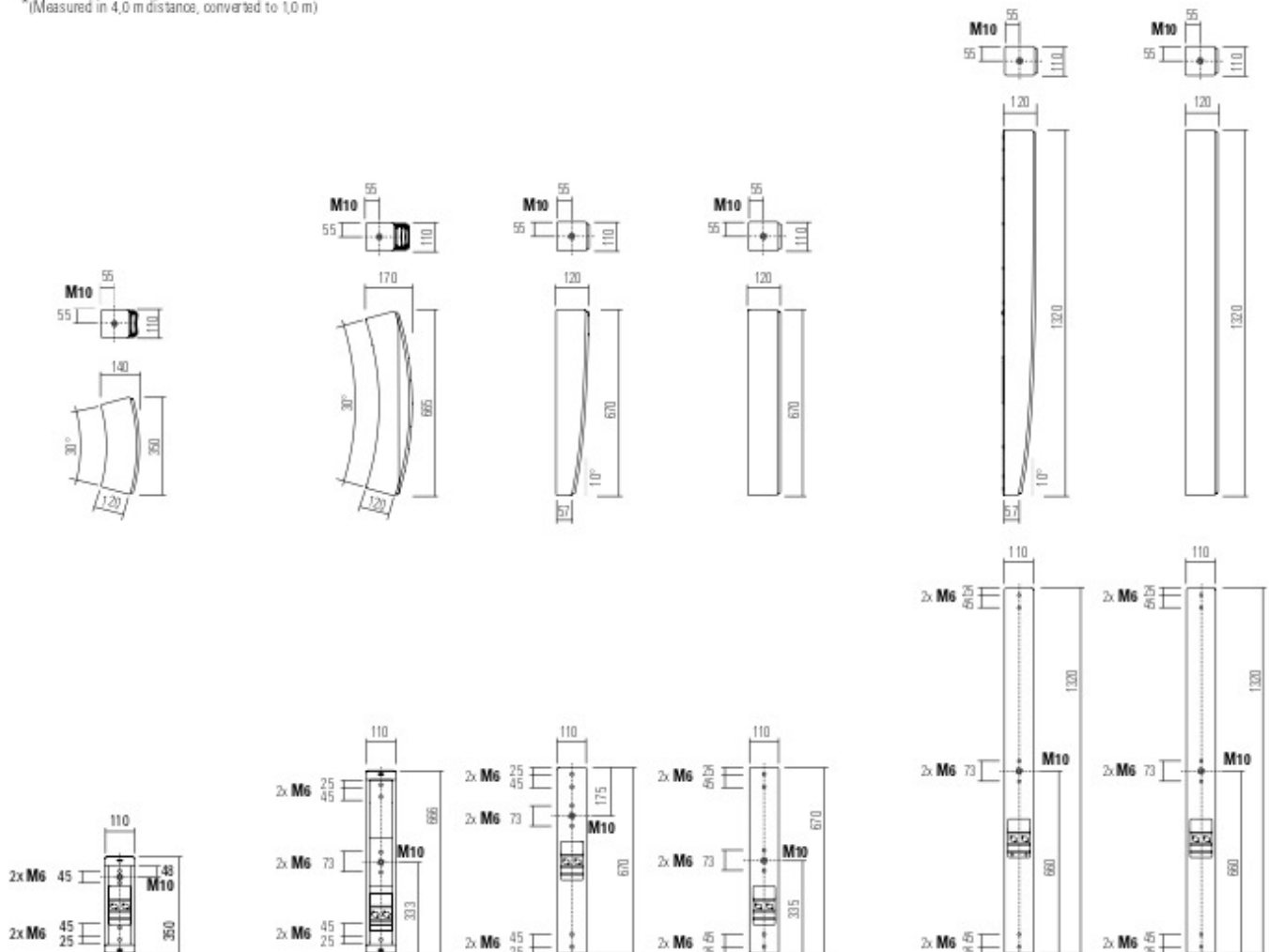

Conventional column speaker

Undefined horizontal dispersion below 2 kHz, narrow beam at higher frequencies (20° at 10 kHz). Vertically: Insufficient coupling above 5 kHz leading to so called "side lobes".

horizontal - 2D Directivity Plot

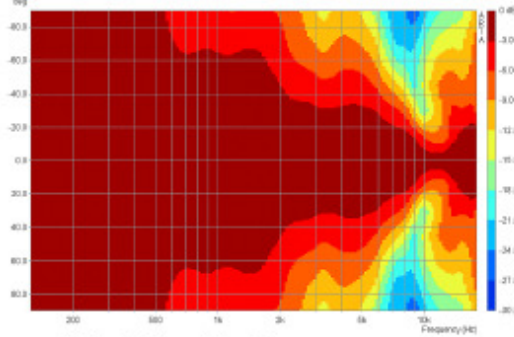

vertikal - 2D Directivity Plot

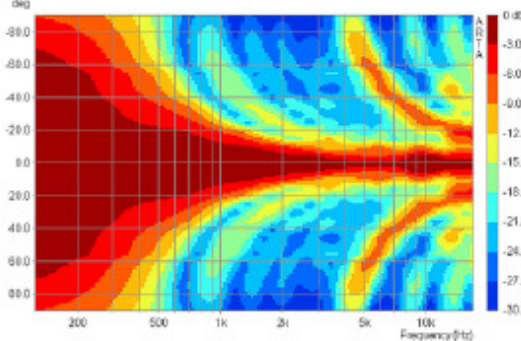

The acoustical coupling of the L-Series single sources leads to strong vertical beaming, making for longer throw and a more homogeneous sound dispersion. The curved design (j- or c- versions) improves the dispersion for the near field. With increasing length of the total column, the ratio of direct sound to reflections will be improved, resulting in more gain before feedback and notably better speech intelligibility.

Controller Setups:

<http://www.seeburg.net/en/downloads>

L 8i - Column speaker with waveguide-technology

Enhanced horizontal directivity at the mid frequencies, notable widening at high frequencies. Vertically: Cylindric wave characteristics up to 9 kHz, strong reduction of the side lobes.

horizontal - 2D Directivity Plot

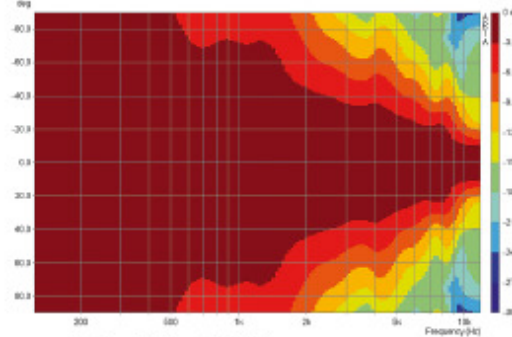

vertikal - 2D Directivity Plot

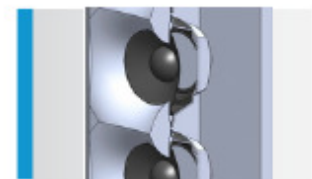
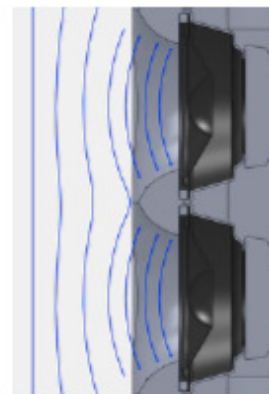
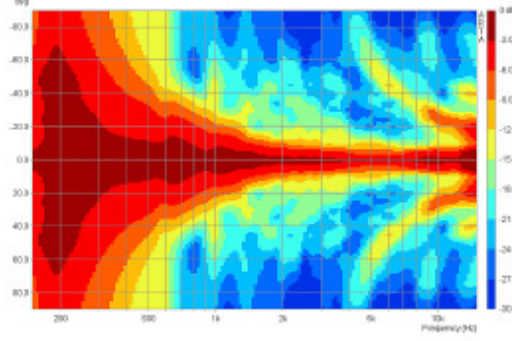

Optimized waveguides for improved vertical coupling and smooth horizontal dispersion.

Dispersion: L 16i and L 16j

The L 16j system is suited for distances of 2 m to 25 m. Longer throw can be accomplished by adding a L 16i on top.

Perfect sound from the first to the last row of seats.



APPLICATION

All six versions of the L-Series speakers can be combined as desired.

Special accessories are available for installation.

The free software EASE Focus can be used to simulate the acoustical results. For more complex designs, the data for simulation software like EASE, Ulysses and CATT-acoustic is available.

CONNECTION



Connection of two L-Series elements by an M10 thread bolt and washer. The two elements can be faced in different horizontal directions.



Mounting to the wall by a bracket with elongated hole. This also enables a slight inclination of the speaker line.



Connection of two elements by tilt adapter. The main dispersion is preadjusted in two directions. Tilt adapters are available with 5°, 10° and 15° angles.



For wall mounting above the field of vision, plates for depth compensation can be used to incline the system without significantly increasing the distance to the wall.



L16i / L16j

Classic long throw application.



L8i / L8c / L4c

Application for higher mounting position.



L16i / L8j

L8j turned inside for better horizontal coverage of the near field.



L8i / L8i / L8j

Three L8 mounted to the wall above the field of vision with small distance to the wall. Separately powered, with delays.

Truss Clamp



incl. M10 Adapter,
max. load 15 kg
Order No. **01221**

Flange



with ball and socket joint,
with additional locking screw,
M10 x 15, max. load 15 kg
Order No. **08125**

Flange



for flying brackets,
35 mm \emptyset \rightarrow M10,
Order No. **08126**

Pole Mount



for L-Series,
35 mm \emptyset \rightarrow M10,
adjustable
Order No. **08126/adj**

Pole Mount



for L-Series,
2 x fixing holes (d=73 mm),
adjustable
Order No. **08126/L-Series**

Wall Mount



M10, max. load 15 kg,
for permanent installation,
incl. tilt angle stop
Order No. **08131/F**
Order No. **08131/F/W** (white)

Wall Mount



ball and socket joint flange (08125) +
08125/plate
Order No. **08125/set**

Wall Mount



2 x M6 fixing holes (d=73 mm),
1 x M10 fixing hole (center),
max. load 25 kg
Order No. **03034**

Speaker Pole



M20, adjustable, K&M
Order No. **03022**



ACCESSORIES L-SERIES

Tilt Adapter

for L-Series, 0° - 5° - 10° - 15°



Order No. **08149/tilt/0°**

Order No. **08149/tilt/5°**

Order No. **08149/tilt/10°**

Order No. **08149/tilt/15°**

Angle Bracket

for L-Series



Order No. **08149/angle bracket**

Plate for Depth Compensation

for L-Series



Order No. **08149/depth compensation**

Thread Bolt

M10 x 30 mm, incl. rubber washer



Order No. **08149/bolt**

Steel Safety

4 mm x 600 mm, black,
max. load 10 kg (BGI 810-3),
quick connector undetachably



Order No. **01376/4**

Base Plate, Small

for GL 16 / GL Sub / L-Series
with M20 flange, 61,5 x 48,0 cm

Order No. **01278/M20**

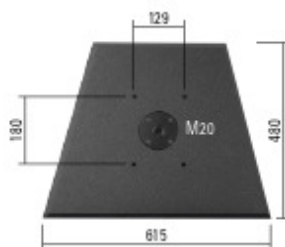

Base Plate, Round

M20, K&M,
ø 450 mm, height: 21 mm
black zinc die-cast, felt strips on
the bottom, weight: 6,7 kg

Order No. **01278/round**



Bag

Universal bag for
small base plate and accessories
with side pocket
62,0 x 23,0 x 51,0 cm

Order No. **01227**



Bag

for 2 x L 16 and accessories

Order No. **01231**



Tool Set for Powerstick

consisting of: wooden plate
with M20 and M10 screws,
matching keys, magnetic bits

Order No. **00750/tool**



Powerstick

for L-Series and multiple use,
2 x 500 W RMS, DSP, 4 x presets,
size (h x w x d): 50,8 x 8,5 x 8,2 cm

Order No. **00750/dp**



Monopods for L-Series

Size and design like L 16j,
to be fixed with M20 on bottom
and M10 on top

Order No. **00750/L16j**

Size and design like L 8i,
to be fixed with M20 on bottom
and M10 on top

Order No. **00750/L8i**

