

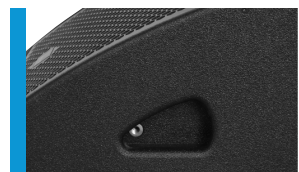

Ultra flat stage monitor fitted with light-weight coaxial 12" / 1.4" Neodym drivers and an integrated digital amplifier electronics with a DSP controller featuring four presets to suit various applications. With high power reserves, homogeneous sound distribution and low tendency to feedback, the M 1 is a tool that will greatly simplify a sound engineer's job. Combined with the optional flying bracket, the system can also be used both as a down-fill and as a universal sound system.

PRODUCT SPECIFICATIONS

Speaker Components	12" Nd / 1,4" Nd Coaxial
Description	Low Profile Monitor
Amp Power	LF: 1000 W AES / 110-230 V HF: 350 W AES / 110-230 V
Rated Current	0,85 A @ 230 V
SPL <small>Peak @ 1 m</small>	133 dB
Max. Input Signal	25 dBu
DSP	HDLM FPGA Processing 32 bit floating point
AD / DA	24 bit / 96 kHz
Latency	0,8 ms (analog in to analog out)
Usable Range	80 Hz - 19 kHz (- 6 dB)
Tuning Frequency <small>excursion minimum</small>	90 Hz
X - Overpoint <small>acoustical</small>	Depends on preset
Coverage <small>horizontal / vertical</small>	60° - conical
Max. Splay Angle	- - -
Connectors	Neutrik XLR in/out Neutrik PowerCon in/out
Handles	2 x
Rigging / Fittings	2 x M10
Weight	17 kg
Size <small>height x width x depth</small>	27,4 x 40,0 x 47,0 cm
Order No.	01068/dp



The attractively formed handle cutouts guarantee comfortable handling.



The connectors are good face accessible to the user.



DIMENSIONS

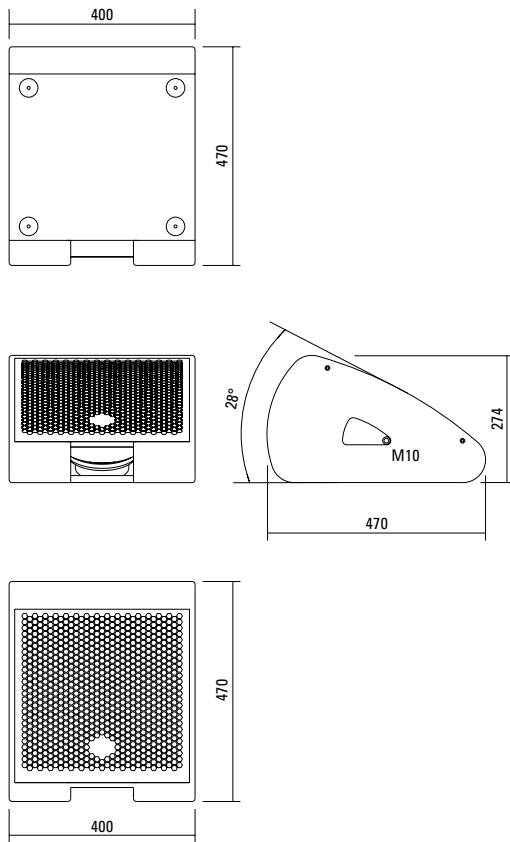

MEASUREMENT

2D Directivity Plot - horizontal

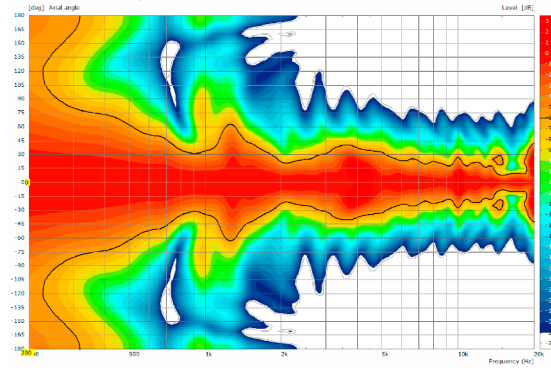

Frequency Response

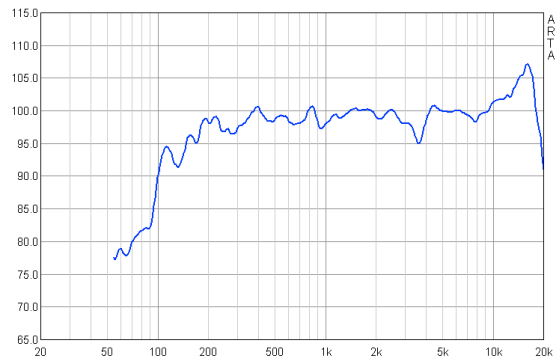

APPLICATIONS

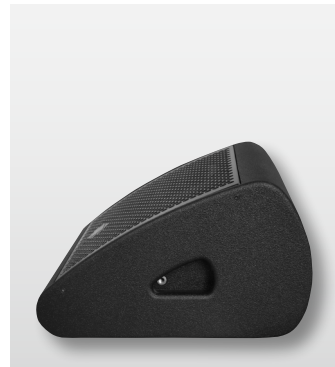
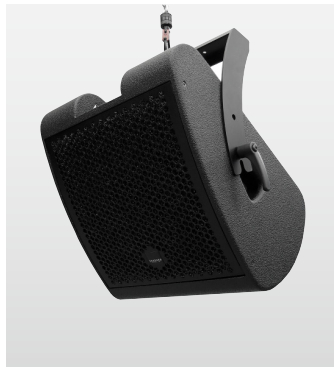

The M 1 dp features integrated digital amplifier electronics with a DSP controller. Various factory-configured presets and volume settings can be selected.

High-grade electronic components from the industrial sector

and a first-class circuit design ensure excellent audio quality with low distortion and a minimal noise floor.

Highly efficient and "intelligent" limiter systems ensure optimum protection against overload, without restricting the possibilities offered by this high-performance sound system.

Mode - key
Switches between control modes: Status, Level and Presets.

Set - key
Setting of various values and Mute on / off.

XLR
Symmetrical analog input, max. Input +25 dBu. Effective filter protection against HF interference and DC Voltages. Virtual ground lift.

PowerCon (grey)
~110-230 V / 16 A max. loop through connector

PowerCon (blue)
Power supply ~110-230 V / 16 A max.

Presets
Flat
This setting provides a linear frequency response with a neutral sound characteristics. Standard setting for many applications.
Floor
Low-mid correction to compensate for coupling effects with a floor surface.
Low
Reduction in the low-mid range to compensate for coupling effects between two monitors.
Soft
Reduces the level in the frequency range from 2.5 - 5 kHz, to which the ear is particularly sensitive. This setting is recommended for high level reproduction of highly compressed music tracks.

Level
Adjustment in 3 dB steps (-6 dB to +3 dB).

Status
Mute LED
Red light when the system is muted or under technically critical conditions.
Limit LED
Yellow light when the limiter is restricting the level.
Signal LED
Green light when the input signal exceeds -20 dBu.
Power LED
Green light when the system is switched on.

M1dp
Low Profile Monitor digitally powered

Serial No.:
Amp Power AES LF 1000W/HF 350W
max. SPL @ 1 m 133 dB
Frequency Range 80 Hz - 19 kHz
Weight 17 kg

Made in Germany
www.seeburg.net

SEEBURG
acoustic line

ACCESSORIES M 1 dp

Flying Bracket



for M 1
incl. screws
(per unit: 2 pcs. M10 x 60 adjustable
handle screws)
Order No. **01202**

Handle Screw



for flying brackets, adjustable
M10 x 60
Order No. **08375/60**

Flange



35 mm Ø → M10,
Order No. **08126**

Doughty Quick Trigger Clamp



max. load 250 kg
Order No. **01223/250 kg**

Ring Screw



M10– DIN 580
Order No. **73700**

TV Spigot



10 mm internal thread,
28 mm Ø
Order No. **08128**

Steel Safety



6 mm x 600 mm, black,
max. load 22 kg (BGI 810-3),
quick connector undetachably
Order No. **01376/6**

Chain Fastener



VBS 7 mm
Order No. **01378**

Rain Cover

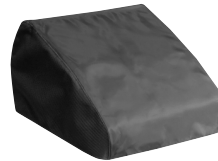

for M 1
Order No. **01228/outdoor**

Flight Case



for 2 pcs. M 1,
heavy duty, 9 mm birch multiplex,
PVC coated, hinged lid, 6 x recessed
sprung handles, 2 x butterfly catches,
4 x 100 mm blue wheels, 2 pcs. with
brake, stackable, interior lined with felt
Order No. **16015/pro**

Hybrid Cable System



PowerCon-PowerCon / XLR-XLR
2,5 m Order No. **08462**
5 m Order No. **08464**
10 m Order No. **08466**
15 m Order No. **08468**